

For the electronic measurement of current: DC, AC, pulsed..., with galvanic separation between the primary and the secondary circuit.

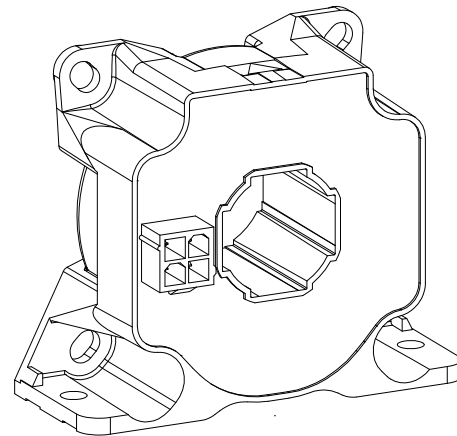

Features

- Bipolar and insulated current measurement up to 500 A
- Current output
- Closed loop (compensated) current transducer
- Panel mounting.

Special feature

- Connection to secondary circuit on MOLEX Mini-Fit Jr 5566 connector (gold plated).

Advantages

- High accuracy
- Very low offset drift over temperature.

Applications

- Single or three phase inverters
- Propulsion and braking choppers
- Propulsion converters
- Auxiliary converters
- Battery chargers.

Standards

- EN 50155: 2007
- UL 508: 2010.

Application Domain

- Traction.

Absolute maximum ratings

Parameter	Symbol	Unit	Value
Maximum supply voltage (working) (-40 ... 85 °C)	$\pm U_C$	V	±21
Primary conductor temperature	T_B	°C	100
Maximum steady state primary current (-40 ... 85 °C)	I_{PN}	A	300

Stresses above these ratings may cause permanent damage.
Exposure to absolute maximum ratings for extended periods may degrade reliability.

UL 508: Ratings and assumptions of certification

File # E189713 Volume: 2 Section: 9

Standards

- USR indicates investigation to the Standard for Industrial Control Equipment UL 508.
- CNR indicates investigation to the Canadian standard for Industrial Control Equipment CSA C22.2 No. 14-13

Conditions of acceptability

When installed in the end-use equipment, consideration shall be given to the following:

- 1 - *These products must be mounted in a suitable end-use enclosure.*
- 2 - *The secondary pin terminals have not been evaluated for field wiring.*
- 3 - *Low voltage control circuit shall be supplied by an isolating source (such as transformer, optical isolator, limiting impedance or electro-mechanical relay).*
- 4 - *Based on the temperature test performed on all Series, the primary bar or conductor shall not exceed 100 °C in the end use application.*

Marking

Only those products bearing the UL or UR Mark should be considered to be Listed or Recognized and covered under UL's Follow-Up Service. Always look for the Mark on the product.

Insulation coordination

Parameter	Symbol	Unit	Value	Comment
Rms voltage for AC insulation test, 50 Hz, 1 min	U_d	kV	3.8	
Impulse withstand voltage 1.2/50 μ s	\hat{U}_w	kV	10	
Insulation resistance	R_{IS}	M Ω	1000	measured at 3.8 kV AC
Comparative tracking index	CTI		600	
Application example			300 V CAT III, PD2	Reinforced insulation, non uniform field according to EN 50178, IEC 61010
Application example			1000 V CAT III, PD2	Basic insulation, non uniform field according to EN 50178, IEC 61010
Case material	-	-	V0 according to UL 94	
Clearance and creepage	See dimensions drawing on page 7			

Environmental and mechanical characteristics

Parameter	Symbol	Unit	Min	Typ	Max	Comment
Ambient operating temperature	T_A	$^{\circ}$ C	-40		85	
Ambient storage temperature	T_S	$^{\circ}$ C	-50		90	
Mass	m	g		107		

Electrical data

At $T_A = 25\text{ °C}$, $\pm U_C = \pm 15\text{ V}$, $R_M = 1\ \Omega$, unless otherwise noted.

Lines with a * in the conditions column apply over the $-40 \dots 85\text{ °C}$ ambient temperature range.

Parameter	Symbol	Unit	Min	Typ	Max	Conditions
Primary nominal rms current	I_{PN}	A			300	*
Primary current, measuring range	I_{PM}	A	-500		500	*
Measuring resistance	R_M	Ω	0			* Max value of R_M is given in figure 1
Secondary nominal rms current	I_{SN}	A	-0.15		0.15	*
Resistance of secondary winding	R_S	Ω			22.5	$R_S(T_A) = R_S \times (1 + 0.004 \times (T_A + \Delta\text{temp} - 25))$ Estimated temperature increase @ I_{PN} is $\Delta\text{temp} = 15\text{ °C}$
Secondary current	I_S	A	-0.25		0.25	*
Number of secondary turns	N_S			2000		
Theoretical sensitivity	G_{th}	mA/A		0.5		
Supply voltage	$\pm U_C$	V	± 11.4		± 21	*
Current consumption	I_C	mA		$33 + I_S$ $35 + I_S$ $38 + I_S$		$\pm U_C = \pm 12\text{ V}$ $\pm U_C = \pm 15\text{ V}$ $\pm U_C = \pm 20\text{ V}$
Offset current, referred to primary	I_O	A	-0.2		0.2	
Temperature variation of I_O , referred to primary	I_{OT}	A	-0.2		0.2	*
Magnetic offset current, referred to primary	I_{OM}	A		± 0.2		After $3 \times I_{PN}$
Sensitivity error	ϵ_G	%	-0.1		0.1	*
Linearity error	ϵ_L	% of I_{PN}	-0.05		0.05	*
Overall accuracy at I_{PN}	X_G	% of I_{PN}	-0.2 -0.2		0.2 0.2	* 25 ... 85 °C -40 ... 85 °C
Output rms current noise referred to primary	I_{no}	mA		35		1 Hz to 100 kHz (see figure 4)
Reaction time @ 10 % of I_{PN}	t_{ra}	μs		0.5		0 to 300 A, 100 A/ μs $R_M = 10\ \Omega$
Step response time to 90 % of I_{PN}	t_r	μs		0.5		0 to 300 A, 100 A/ μs $R_M = 10\ \Omega$ (see figure 2)
Frequency bandwidth	BW	kHz		100		$R_M = 50\ \Omega$; -3 dB

Definition of typical, minimum and maximum values

Minimum and maximum values for specified limiting and safety conditions have to be understood as such as values shown in "typical" graphs.

On the other hand, measured values are part of a statistical distribution that can be specified by an interval with upper and lower limits and a probability for measured values to lie within this interval.

Unless otherwise stated (e.g. "100 % tested"), the LEM definition for such intervals designated with "min" and "max" is that the probability for values of samples to lie in this interval is 99.73 %.

For a normal (Gaussian) distribution, this corresponds to an interval between -3 sigma and +3 sigma. If "typical" values are not obviously mean or average values, those values are defined to delimit intervals with a probability of 68.27 %, corresponding to an interval between -sigma and +sigma for a normal distribution.

Typical, minimum and maximum values are determined during the initial characterization of the product.

Typical performance characteristics

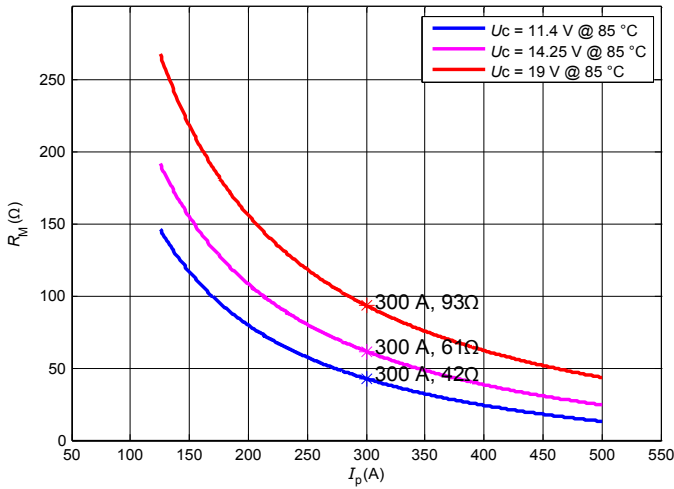

Figure 1: Maximum measuring resistance

$$R_{M \max} = N_s \times \frac{U_{C \min} - 0.3 \text{ V}}{I_p} - R_{S \max} - 2.4 \Omega$$

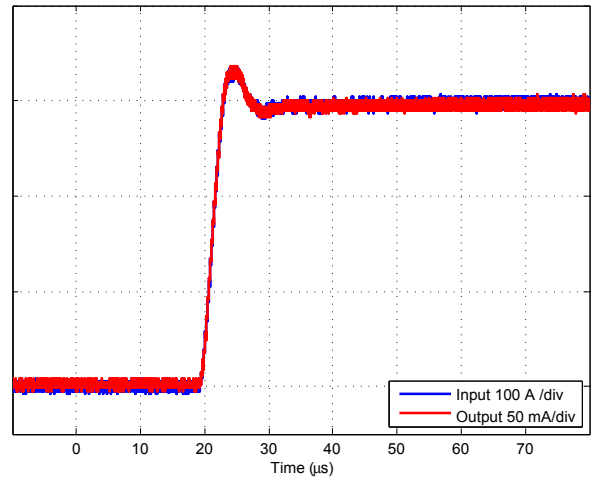

Figure 2: Typical step response (0 to 300 A, 100 A/μs $R_M = 10 \Omega$)

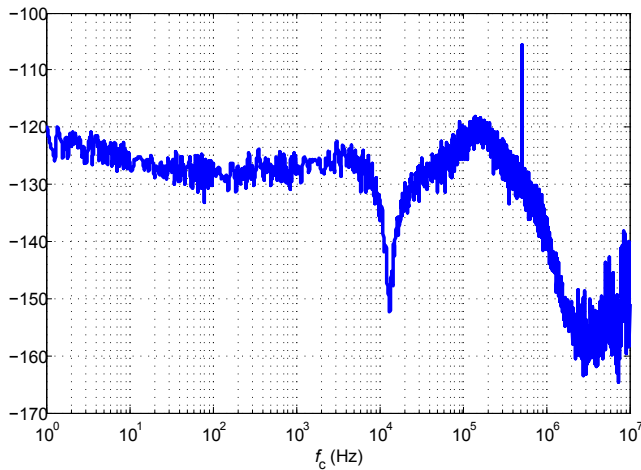

Figure 3: Typical noise voltage density e_{no} with $R_M = 10 \Omega$

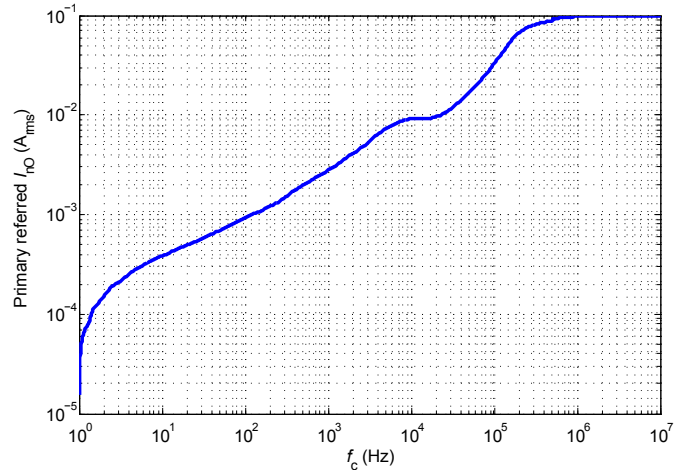

Figure 4: Typical total output current noise with (primary referred, rms) with $R_M = 10 \Omega$

To calculate the noise in a frequency band f_1 to f_2 , the formula is:

$$I_{no}(f_1 \dots f_2) = \sqrt{I_{no}(f_2)^2 - I_{no}(f_1)^2}$$

with $I_{no}(f)$ read from figure 4 (typical, rms value).

Example:

What is the noise from 10^3 to 10^6 Hz?

Figure 4 gives $I_{no}(10^3 \text{ Hz}) = 3.19 \text{ mA}$ and $I_{no}(10^6 \text{ Hz}) = 84.4 \text{ mA}$.

The output current noise (rms) is therefore:

$$\sqrt{(84.4 \times 10^{-3})^2 - (3.19 \times 10^{-3})^2} = 84.34 \text{ mA referred to primary}$$

Typical performance characteristics

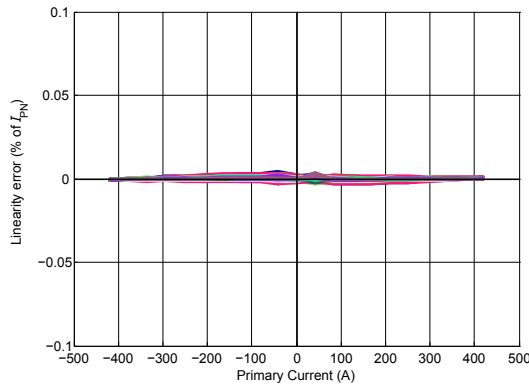

Figure 5: Linearity

Performance parameters definition

Sensitivity and linearity

To measure sensitivity and linearity, the primary current (DC) is cycled from 0 to I_{PM} , then to $-I_{PM}$ and back to 0 (equally spaced $I_{PM}/10$ steps).

The sensitivity G is defined as the slope of the linear regression line for a cycle between $\pm I_{PM}$.

The linearity error ϵ_L is the maximum positive or negative difference between the measured points and the linear regression line, expressed in % of the maximum measured value.

Magnetic offset

The magnetic offset I_{OM} is the change of offset after a given current has been applied to the input. It is included in the linearity error as long as the transducer remains in its measuring range.

Electrical offset

The electrical offset current I_{OE} is the residual output current when the input current is zero.

Overall accuracy

The overall accuracy X_G is the error at $\pm I_{PN}$, relative to the rated value I_{PN} . It includes all errors mentioned above.

Response and reaction times

The response time t_r and the reaction time t_{ra} are shown in the next figure.

Both slightly depend on the primary current di/dt . They are measured at nominal current.

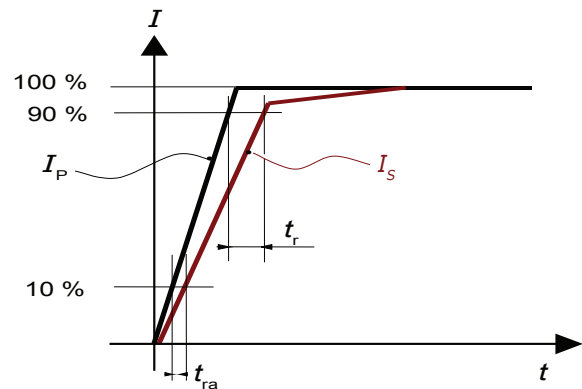
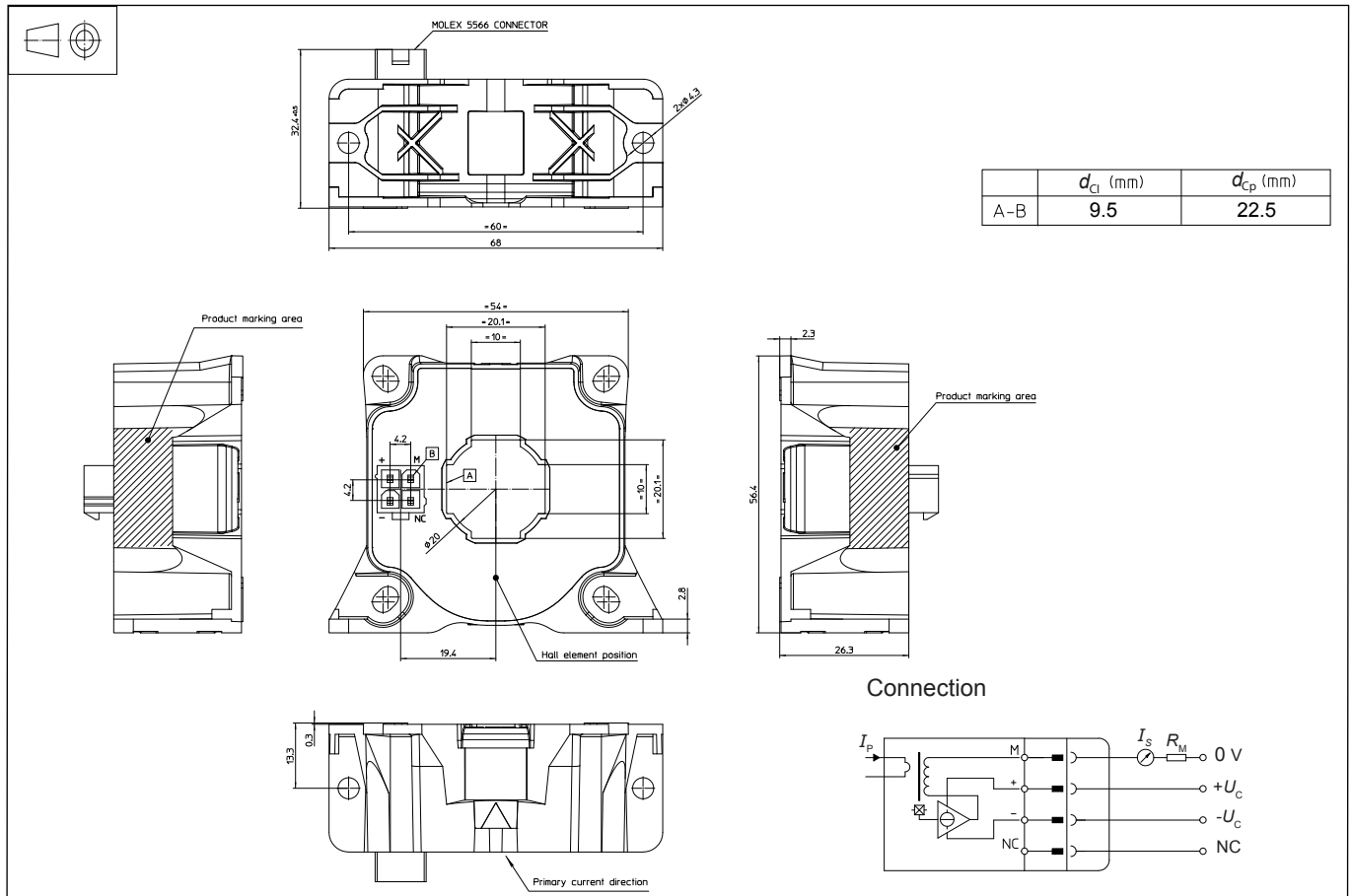

Figure 6: Response time t_r and reaction time t_{ra}

Dimensions (in mm)

Mechanical characteristics

- General tolerance ± 0.3 mm
- Transducer fastening Vertical position
 - 2 holes $\varnothing 4.3$ mm
 - 2 M4 steel screws
 - Recommended fastening torque 2.1 N·m (± 10 %)
- Transducer fastening Horizontal position
 - 4 holes $\varnothing 4.3$ mm
 - 4 M4 steel screws
 - Recommended fastening torque 2.1 N·m (± 10 %)
- Connection of secondary MOLEX Mini-Fit Jr 5566
- Primary through hole $\varnothing 20$ mm

Remarks

- I_S is positive when I_P flows in the direction of arrow.
- The secondary cables also have to be routed together all the way.
- Installation of the transducer is to be done without primary current or secondary voltage present.
- Maximum temperature of primary conductor: see page 2.
- Installation of the transducer must be done unless otherwise specified on the datasheet, according to LEM Transducer Generic Mounting Rules. Please refer to LEM document N°ANE120504 available on our Web site: [Products/Product Documentation](#).

Safety

This transducer must be used in limited-energy secondary circuits according to IEC 61010-1.



This transducer must be used in electric/electronic equipment with respect to applicable standards and safety requirements in accordance with the manufacturer's operating instructions.



Caution, risk of electrical shock

When operating the transducer, certain parts of the module can carry hazardous voltage (eg. primary connection, power supply).

Ignoring this warning can lead to injury and/or cause serious damage.

This transducer is a build-in device, whose conducting parts must be inaccessible after installation.

A protective housing or additional shield could be used.

Main supply must be able to be disconnected.